

**stafil**  
textile

**-50%**

## Gesichtsmasken

coprivo | face cover | couvercle visage

100010-449

## Gesichtsabdeckung Größe S/M | copriviso taglia S/M | face cover size S/M | couvercle visage taille S/M

240134-.. VE 10St



**-01**  
Schmetterlinge | farfalle |  
butterflies | papillons



**-03**  
Blumen rot | fiori rossi |  
red flowers | fleurs rouges

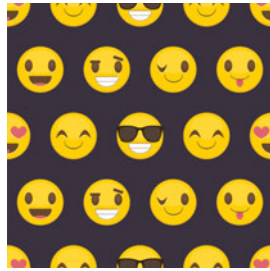

**-04**  
Smile | smile |  
smile | smile



## Gesichtsabdeckung Größe M/L | copriviso taglia M/L | face cover size M/L | couvercle visage taille M/L

240134-.. VE 10St



**-02**  
Camouflage blau | camouflage blu |  
camouflage blue | camouflage bleu

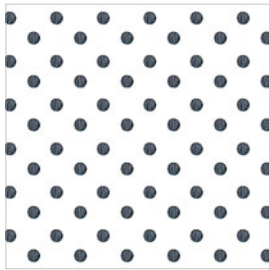

**-05**  
Pois | pois | pois | pois

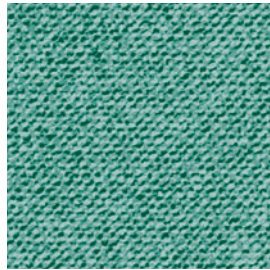

**-06**  
grün Melange | verde melange |  
green melange | vert melange

Gesichtsabdeckung Größe L |  
copriviso taglia L | face cover size L |  
couvercle visage taille L

240134-.. VE 10St



**-07**  
Pois | pois | pois | pois

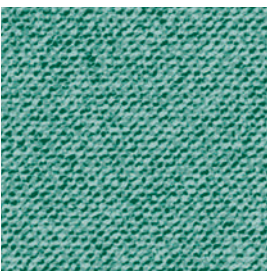

**-08**  
grün Melange | verde melange |  
green melange | vert melange

**Interlock  
Waterrepellent  
100% Polyester  
120g/m<sup>2</sup>**



ausßen  
esterno  
outside  
extérieur

Dieser Stoff genügt höchsten Ansprüchen an Funktionalität durch die Kombination von hoher Elastizität und Atmungsaktivität.

Questo tessuto unisce due importanti caratteristiche, un'ottima elasticità e una eccezionale traspirabilità. Il corpo rimane asciutto e mantiene la temperatura ideale.

This fabric combines two important characteristics: excellent elasticity and high breathability guaranteeing the right body temperature and keeping you dry.

Cette fibre combine deux importantes caractéristiques: une excellente élasticité et une excellente perméabilité à l'air garantissant une bonne température du corps et un maintien au sec.

**Crono Sanitized  
Antibacterial  
100% Polyester  
135g/m<sup>2</sup>**



innen  
interno  
inside  
intérieur

Dieser sehr weiche, elastische Mikrofaserstoff ist atmungsaktiv und hat einen sehr hohen Feuchtigkeitstransport. Die Sanitized-Behandlung des Stoffes kann die Viruslast um bis zu 99% reduzieren und bietet zudem einen hervorragenden Schutz gegen Bakterien.

Questo tessuto in microfibra è molto morbido, elastico e traspirante. Il trattamento Sanitized del tessuto può ridurre la carica virale fino al 99% e fornisce anche un'eccellente protezione contro i batteri.

This very soft, elastic microfibre fabric is breathable and has a very high moisture transport. The Sanitized treatment of the fabric can reduce the viral load by up to 99% and also provides excellent protection against bacteria.

Ce matériau en microfibre très doux et élastique est respirant et a un très fort pouvoir de transport de l'humidité. Le traitement hygiénique du tissu peut réduire la charge virale jusqu'à 99% et offre également une excellente protection contre les bactéries.





**Kopfschlauchtuch Kinder** | scaldacollo per bambini |  
headwear&neckwear for children | cache-cou pur enfant

240133-.. VE 10St, 46x34cm



-01  
Hasen/Luftballons | conigli/palloncini |  
rabbits/balloons | lièvres/ballons



Interlock  
Waterrepellent  
100% Polyester  
120g/m<sup>2</sup>



OEKO-TEX®  
CONFIDENCE IN TEXTILES  
STANDARD 100





**Bedruckter Interlock Stoff** | tessuto Interlock stampato | printed Interlock fabric | tissu Interlock imprimé

240135-.. VE 10St, 50x40cm



-01  
Hasen/Luftballons | conigli/palloncini |  
rabbits/balloons | lièvres/ballons



-02  
Schmetterlinge | farfalle |  
butterflies | papillons



-03  
Camouflage blau | camouflage blu |  
camouflage blue | camouflage bleu

Interlock  
100% Polyester  
120g/m<sup>2</sup>

OEKO-TEX®  
CONFIDENCE IN TEXTILES  
STANDARD 100



-04  
Blumen rot | fiori rossi |  
red flowers | fleurs rouges

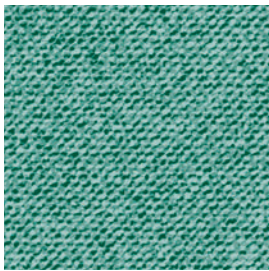

-06  
grün Melange | verde melange |  
green melange | vert melange

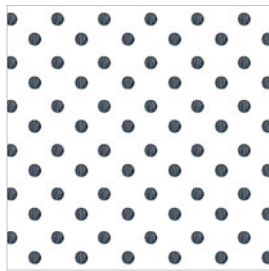

-07  
Pois | pois | pois | pois



**Crono Stoff** | tessuto Crono |  
Crono fabric | tissu Crono

240136-.. VE 10St, 50x40cm



-01  
weiss | bianco |  
white | blanc

**Crono Sanitized  
Antibacterial  
100% Polyester  
135g/m<sup>2</sup>**



innen  
interno  
inside  
intérieur

Dieser sehr weiche, elastische Mikrofaserstoff ist atmungsaktiv und hat einen sehr hohen Feuchtigkeitstransport. Die Sanitized-Behandlung des Stoffes kann die Viruslast um bis zu 99% reduzieren und bietet zudem einen hervorragenden Schutz gegen Bakterien.

Questo tessuto in microfibra è molto morbido, elastico e traspirante. Il trattamento Sanitized del tessuto può ridurre la carica virale fino al 99% e fornisce anche un'eccellente protezione contro i batteri.

This very soft, elastic microfibre fabric is breathable and has a very high moisture transport. The Sanitized treatment of the fabric can reduce the viral load by up to 99% and also provides excellent protection against bacteria.

Ce matériau en microfibre très doux et élastique est respirant et a un très fort pouvoir de transport de l'humidité. Le traitement hygiénique du tissu peut réduire la charge virale jusqu'à 99 % et offre également une excellente protection contre les bactéries.



SCHNITTMUSTER MASKEN | MODELLI MASCHERINE  
 PATTERN FOR MASKS | MOTIF POUR MASQUES:

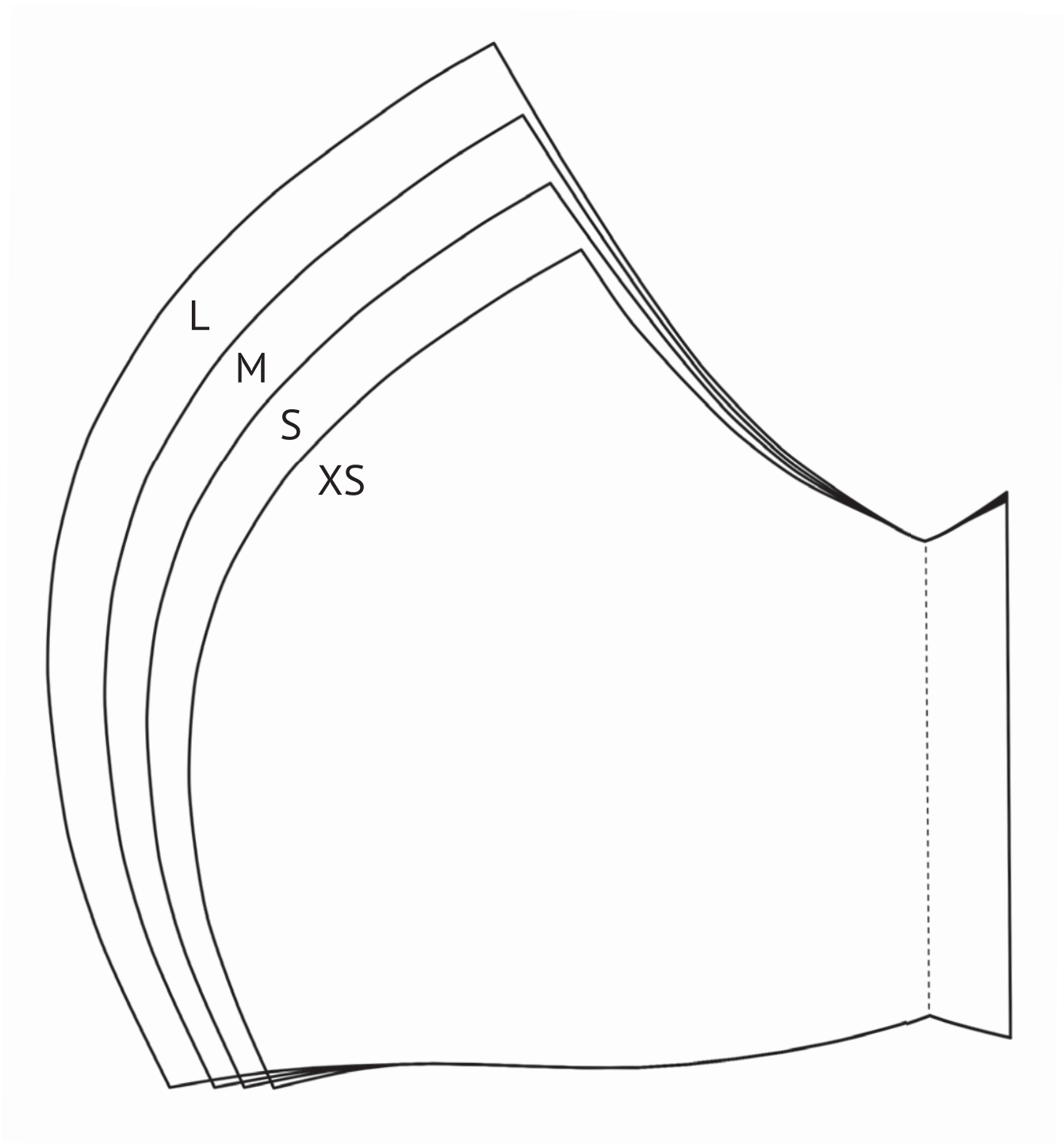

- XS** = Kleinkinder | bambini piccoli | small children | petits enfants  
**S** = Kinder | bambini | children | enfants  
**M** = Erwachsene | adulti | adults | adultes  
**L** = Erwachsene groß | adulti grande | adults large | adultes grands

**5x5cm**

Das Kontrollquadrat muss exakt 5x5cm groß sein. Andernfalls überprüfe die Einstellungen deines Druckers.

Il quadrato di controllo deve essere esattamente 5x5cm. Altrimenti controllate le impostazioni della vostra stampante.

The control square must be exactly 5x5cm. Otherwise check the settings of your printer.

Le carré de contrôle doit être exactement de 5x5cm. Sinon, vérifiez les paramètres de votre imprimante.

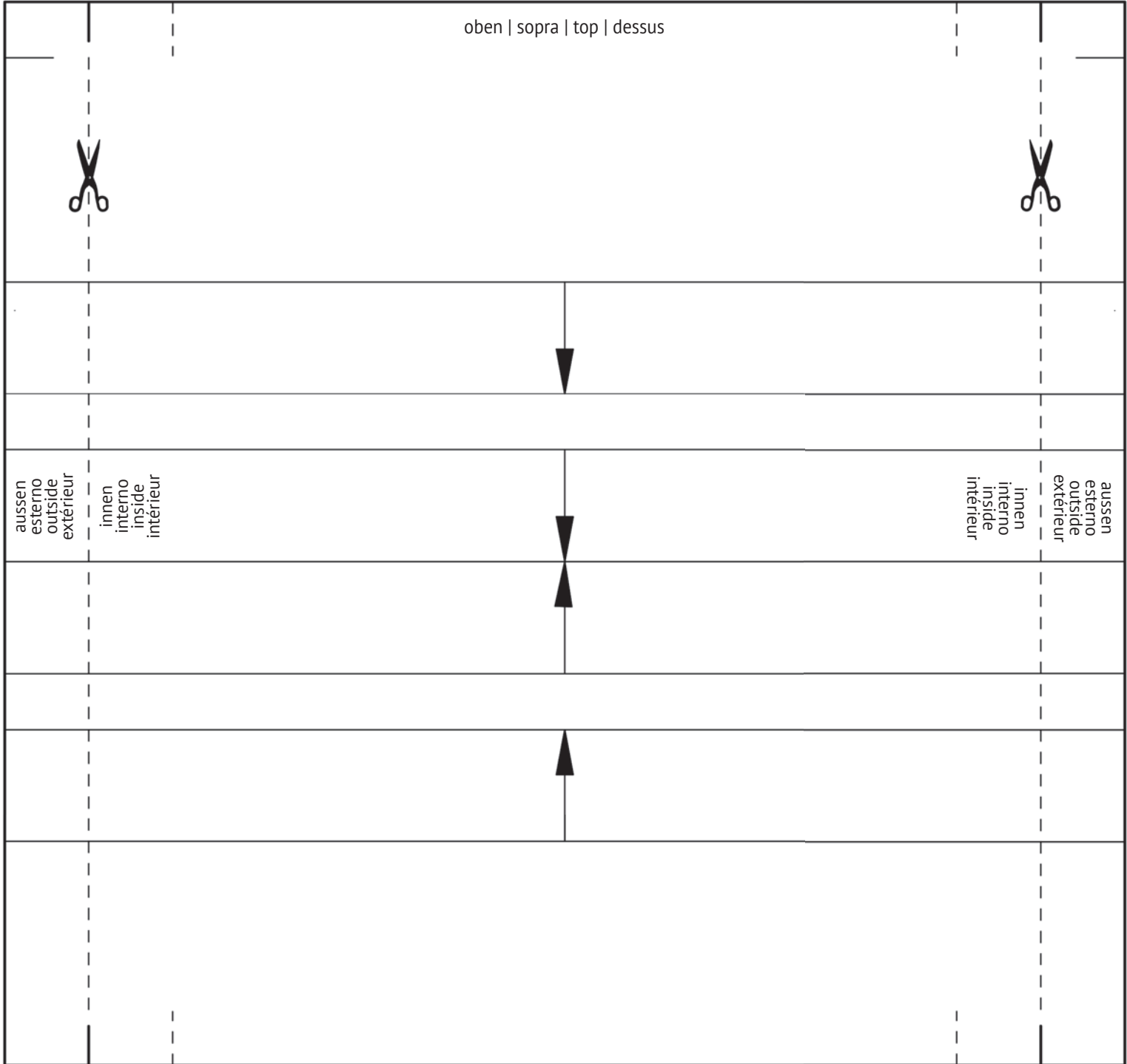

**5x5cm**

Das Kontrollquadrat muss exakt 5x5cm groß sein. Andernfalls überprüfe die Einstellungen deines Druckers.

Il quadrato di controllo deve essere esattamente 5x5cm. Altrimenti controllate le impostazioni della vostra stampante.

The control square must be exactly 5x5cm. Otherwise check the settings of your printer.

Le carré de contrôle doit être exactement de 5x5cm. Sinon, vérifiez les paramètres de votre imprimante.



**stafil**  
textile

100010-449



8 032502 476689

Via Stradivari 6 - 39100 Bolzano (BZ) - Tel. 0471 060300 - Fax 0471 060333 - info@stafil.it - www.stafil.com